

TEAC® WARRANTY PROCEDURE v1.7b: July 2016 for 12M Replacement

Please read the owner's manual carefully and ensure that you have followed the correct installation and operating procedures.

1. Please read this warranty card.
2. Keep your purchase receipt to enable you to proceed quickly in the event of a Warranty Service.
3. If you require Warranty Service, please contact the TEAC Warranty Service Hotline at 1300 553 315 for assistance. Please ensure that you have the model number, serial number and purchase receipt ready when you call.

Please complete the section below and keep this information for your own records.

Owner's Name	
Owner's Address	
Postcode	
Model Name/No.	Serial No.
Dealer's Name	
Dealer's Address	
Postcode	

Thank you for selecting a TEAC product

If your TEAC product malfunctions, please call us directly for warranty support between Monday to Friday at 8.30AM – 5PM AEST at the

TEAC Warranty Service Hotline

1300 553 315

For other enquiries, please contact us at:

www.teac.com.au

When calling to receive warranty service, please have:

1. **Your model and serial number**
2. **Proof of purchase**
3. **And your product in front of you**

NOTE:

- You are required to provide a copy of your proof of purchase in order to have your claim processed.
- Please read the Terms and Conditions for details of your warranty entitlement.

Our goods come with guarantees that cannot be excluded under the Australian Consumer Law. You are entitled to a replacement or refund for a major failure and for compensation for any other reasonably foreseeable loss or damage. You are also entitled to have the goods repaired or replaced if the goods fail to be of acceptable quality and the failure does not amount to a major failure.



1. TEAC warrants that this product is free from defects in material and workmanship under normal domestic use with reasonable care and skill. Maintenance and cleaning (i.e. laser head) is not covered by this warranty. The TEAC warranty only applies to TEAC products purchased NEW from a TEAC Authorised Retailer in Australia. This warranty only applies to the original purchaser and cannot be transferred.
2. The benefits to the consumer given by this Warranty are in addition to other rights and remedies of the consumer under a law in relation to goods or services to which the warranty relates, being the Australian Consumer Law.
3. Refund or replacement via your TEAC Authorised Retailer is available for a period of 14 days after purchase for goods that have been inspected and determined to have a major failure. Refund and exchange is not applicable for change of mind.
4. Subject to the terms herein, this warranty effectively covers TEAC products under the **12 Month Replacement Warranty Scheme**, 12 months from the date of original purchase.
5. The warranty is void and warranty claims may be refused, subject to the Australian Consumer Law, if:
 - a) The product was not transported, installed, operated or maintained according to manufacturer instruction, or
 - b) The product was abused, damaged, tampered, altered or repaired by any unauthorised persons, or
 - c) Product failure is due to accidents during use, installation or transit, power surges, use of defective or incompatible external devices, exposure to abnormal conditions such as excessive temperatures or humidity, or entry of liquids, objects or creatures into the product, cockroach infestations, or
 - d) The customer is unable to provide proof of purchase of the product for verification, or
 - e) The serial number of the product is missing or has been tampered with.
6. No one is authorised to assume any liability on behalf of TEAC or impose any obligation on it, in connection with the sale of any equipment other than as stated in this warranty and outlined above.
7. TEAC and/or its Authorised Service Centres reserve the right to inspect and verify whether the product is exhibiting a major failure as claimed by customers/retailers.

User Manual
DUAL ALARM CLOCK RADIO
CRX150

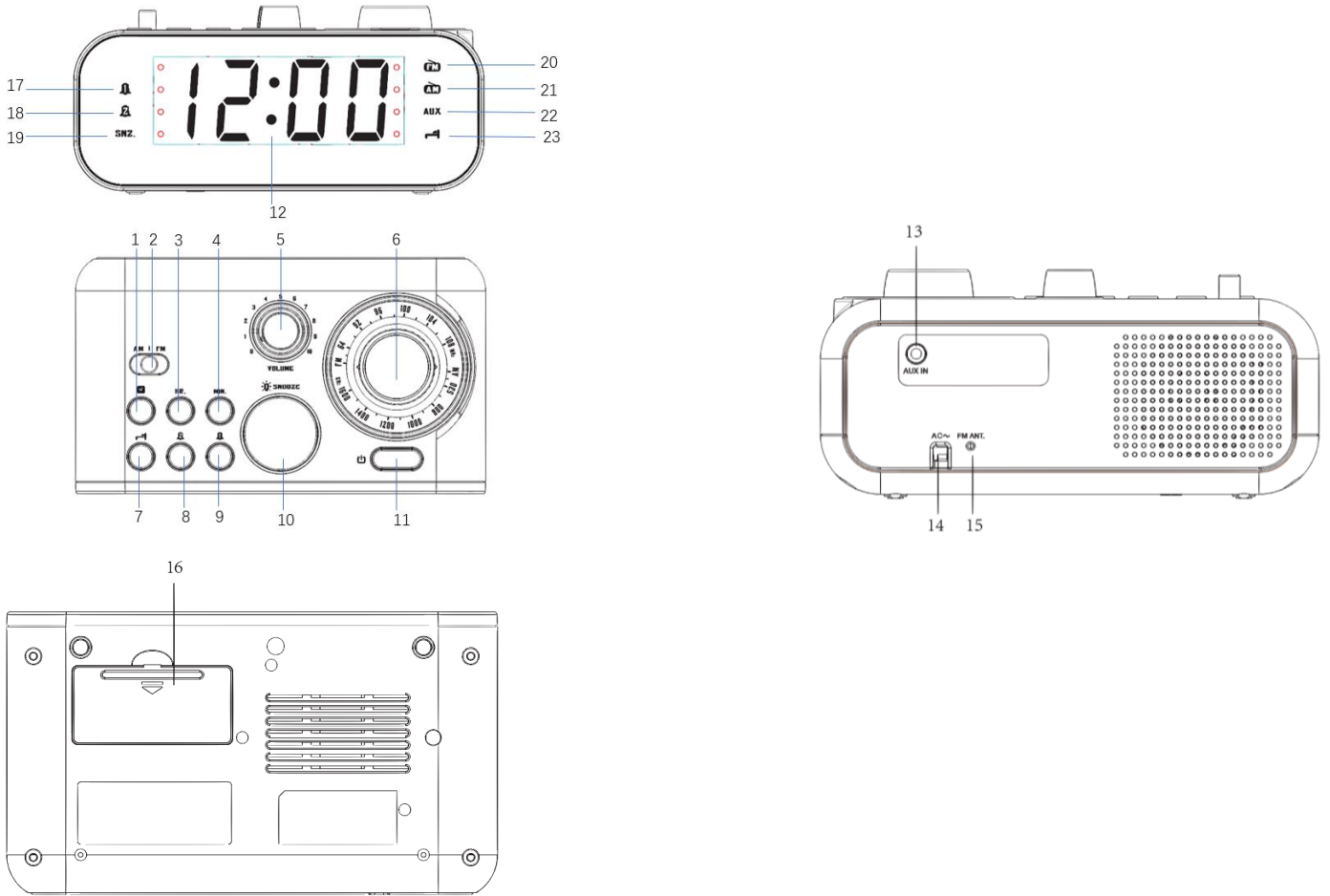
LOCATION AND DESCRIPTION OF CONTROLS



1. setting the clock
2. FM/AM band selector
3. HR. hour setting
4. MIN. minute setting
5. VOLUME knob
6. Tuning control
7. sleep button
8. alarm 2 button
9. alarm 1 button
10. dimmer / snooze button
11. standby button
12. LED display
13. AUX IN jack
14. AC power cord
15. FM antenna wire
16. battery compartment
17. alarm 1 indicator
18. alarm 2 indicator

19. **SNZ**.SNOOZE indicator
20.  FM indicator
21.  AM indicator
22. **AUX** AUX indicator
23.  sleep indicator

POWER SUPPLY

AC: 220V ~ 50Hz



1. Insert the plug of power cord into a standard wall outlet.
 2. Install the batteries in their compartment, 2x1.5V, battery type AAA/R03/UM4 (not provided) **for back-up**
- For optimal performance, alkaline batteries are recommended. These batteries must be replaced every six months.

Use only the size and type of batteries specified. Respect the polarity indicated in the compartment. Improper polarity can cause damage to the device. In order to avoid leakage, remove the batteries when unit will not be used for a long period of time. Do not mix different types of batteries or old batteries with new ones.

CAUTION: Danger of explosion if battery is incorrectly replaced. Replace only with the same or equivalent type.



BACKUP SYSTEM: All settings are memorized, however, the clock time could occasionally need to be readjusted. In case of power failure, if backup batteries are not installed, the screen will flash to indicate this power failure and the necessity to redo your settings.

SETTING THE TIME







1. In standby mode, press and hold  button, the display will flash, set the time with **HR.** hour and/or **MIN.** minutes.
2. Press again  to confirm.

NOTE: If during the adjustment time no key is activated in 9 seconds, the current display will be automatically stored.

LISTENING TO THE RADIO

1. Press  once to turn on the unit.
2. Use the band selector FM/AM to select band.
3. Use the tuning control to tune to your desired radio station.
 FM: For best reception, extend the FM wire antenna.
 AM: Rotate the unit horizontally for optimum reception.
4. Adjust the volume level.
5. To stop listening to the radio, press  again to turn off the unit.

SETTING THE ALARM AND THE ALARM MODE

1. In standby mode, press and hold  for a few seconds, the display blinks.
2. Press **HR.** and/or **MIN.** to set the time of wake up.
3. Press  then press **HR.** or **MIN.** to select the source of wake up:  buzzer or  FM radio.
4. Press  to confirm. The alarm indicator  lights up.

- If you use the sleep mode  with low sound level, you should use the buzzer to wake you up.
- If you wake up with the radio, select your desired station.
- Do not forget to check the volume level.



* Same procedure applies for Alarm 2 with  button.

STOPPING THE ALARM



1-Alarm repetition

Press **SNOOZE**. The alarm stops and will sound again 9 minutes later. The SNOOZE indicator will blink during snooze period.

2-Alarm stop





Press  or . The alarm will sound again the next day at the same time.

3-Alarm Cancellation

In standby mode, press  to cancel the alarm permanently. The alarm indicator  lights off.

* Same procedure applies for Alarm 2 with  button.

SLEEP FUNCTION

To fall asleep with the radio, Press  then  to select 120-90-60-30-15 or 5 minutes of listening.  indicator lights up. The unit will automatically turn off after the specified time. To cancel the sleep function, press  or press  to OFF.

CONNECTING AUXILIARY SOURCE

1. Connect your auxiliary source (e .g. mp3 player) to the **AUX IN** jack on the back of unit (cable not included). The unit will switch to AUX mode automatically. AUX indicator lights up.
2. Start playback from your auxiliary source.
3. Adjust the volume to desired level.
4. To stop playback, disconnect your auxiliary source from the **AUX IN** jack.

DIMMER

Press  to select the brightness of the screen: high, low or OFF.

TECHNICAL SPECIFICATIONS

POWER SUPPLY: AC 240V ~ 50Hz, 4W consumption

DC 2x1.5V, battery type AAA/R03/UM-4 (not provided) for back-up

RADIO: FM 64-108MHz

AM 540-1600kHz

Note: Design and specification are subject to change without notice.

PHYSICAL SPECIFICATIONS

Net weight: 0.485kgs

Gross weight: 0.565kgs

Unit dimensions: 166 x 96 x 76mm

MORE INFORMATION



CAUTION: To reduce the risk of electric shock, do not open the device, there is no party inside for the user. Refer all servicing to qualified personnel.

 The lightning with the arrow symbol in the triangle is a warning sign alerting the user to "dangerous voltage" inside the unit.

 The exclamation point in the triangle is a warning sign alerting the user of important instructions accompanying the product.

The Caution mark is located at the bottom of the device.

IMPORTANT

- Use the device in moderate climates.
- The Marking plate is located at the bottom of the device.
- Make sure to have a minimum distance of 5 cm around the unit for sufficient ventilation.
- Ensure that the ventilation openings are not covered with items such as newspapers, blankets, tablecloths, curtains, etc.
- Do not place naked flame sources, such as lighted candles on the apparatus.

- Do not expose this appliance to dripping or splashing water.
- Do not place objects filled with liquids, such as glasses or vases on the device.
- Do not throw batteries into fire! Respect the environment when disposing of used batteries.
- Batteries should not be exposed to excessive heat such as sunshine, fire or other similar heat source.
- The power plug is used as a disconnect device and must be easily accessible. To be completely disconnected from the power, the plug of the appliance should be disconnected completely. The socket must not be obstructed and should be easily accessible during intended use.
- Under the influence of fast transient and / or electrostatic electric phenomenon, the product may malfunction and the user must perform a power reset of the device



■ If in the future, you need to get rid of this product, please note that Waste electrical products should not be disposed of with household waste. Recycling facilities exist. Check with your municipality or ask your dealer for advice. (Directive for Waste Electrical and Electronic Equipment)

TEAC

In the event of a product failure within the warranty period, please call the

TEAC Warranty Service Hotline

1300 553 315

Between Monday to Friday - 8.30AM to 5PM AEST

*Please have your purchase receipt and the product's serial number ready

For other enquiries and support please visit
www.teac.com.au